

Article number: 12309000030100  
Description: KLEE-coil 309 000 030.100  
M3 Unhardened steel

## Measures

---

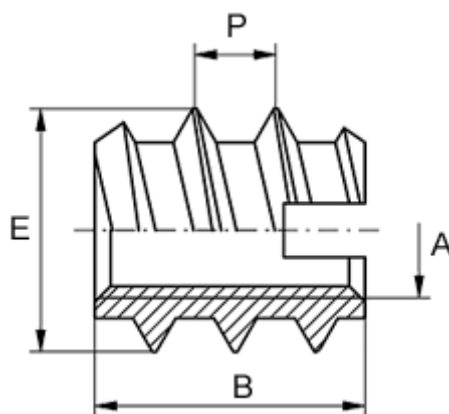

Female thread A	= M3
Length B	= 6
Male thread E	= 6.0
Min hole depth	= 8
Recommended bore diameter (plastic/hard wood)	= 4.2 to 4.3
Recommended bore diameter, soft wood (largest)	= 4.0
Thread pitch P	= 2.0